

FIG. 1

1000

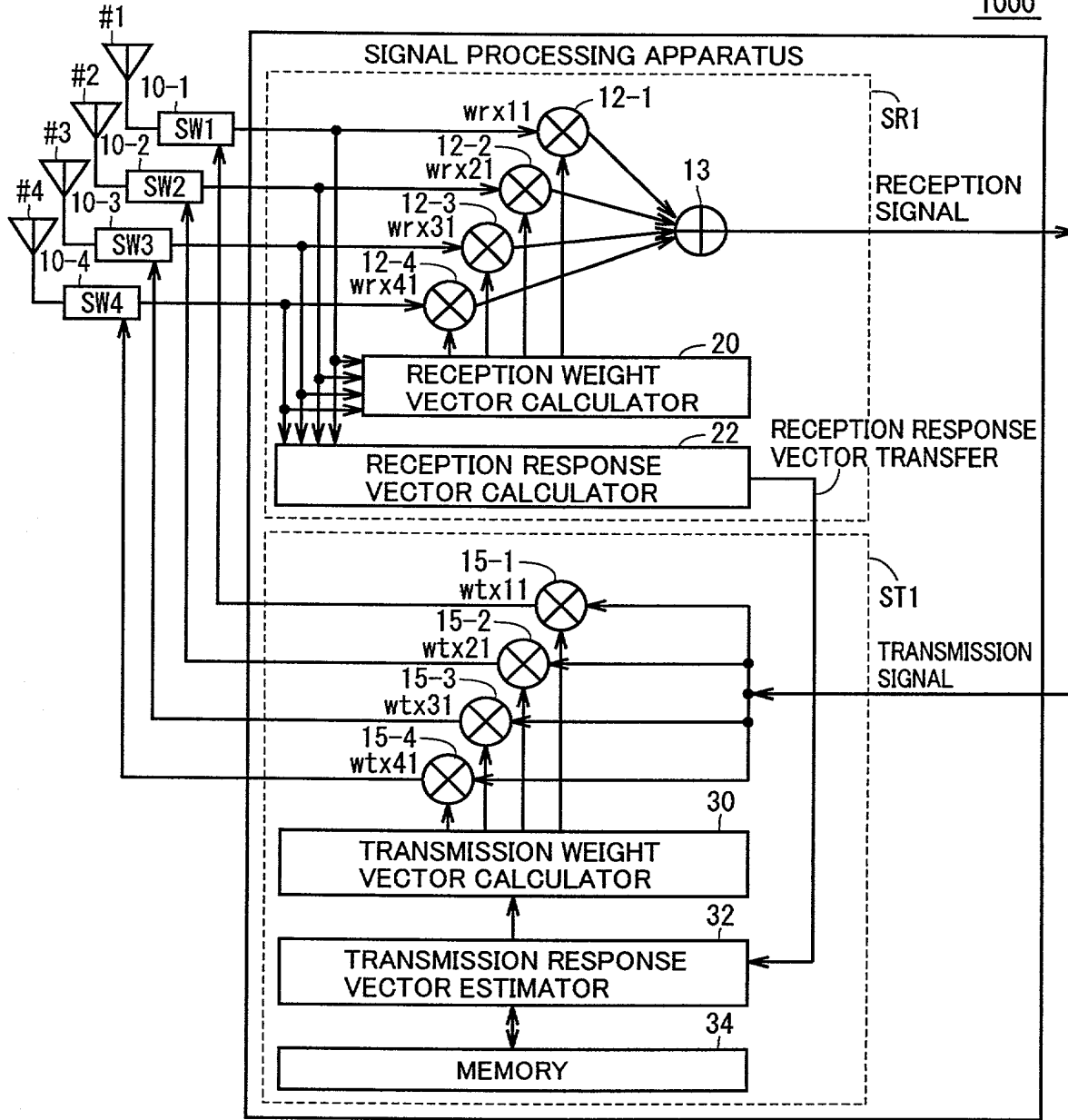

FIG.2

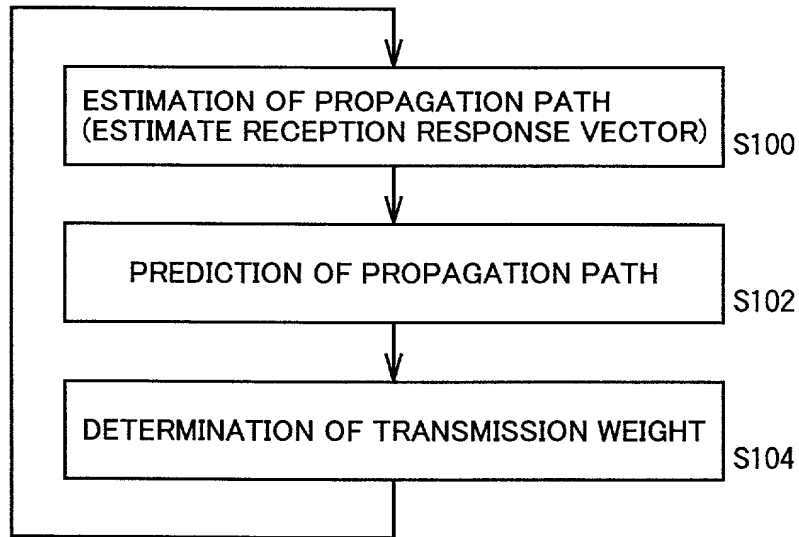

FIG.3

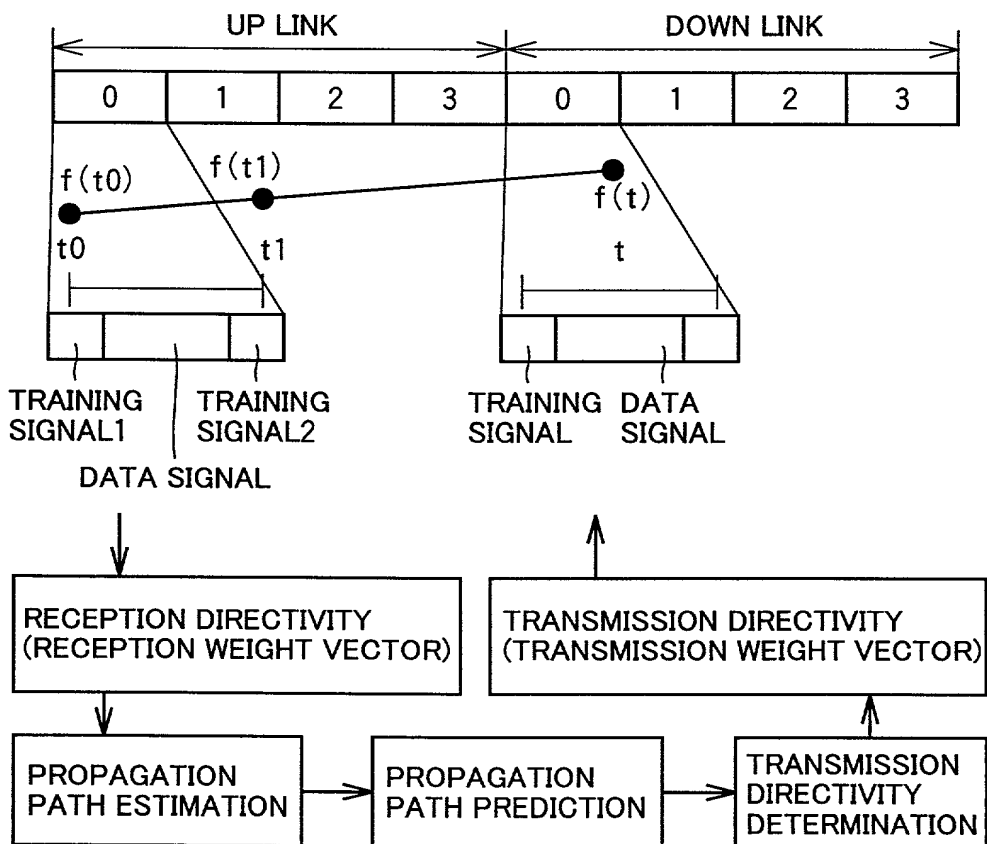

FIG. 4A

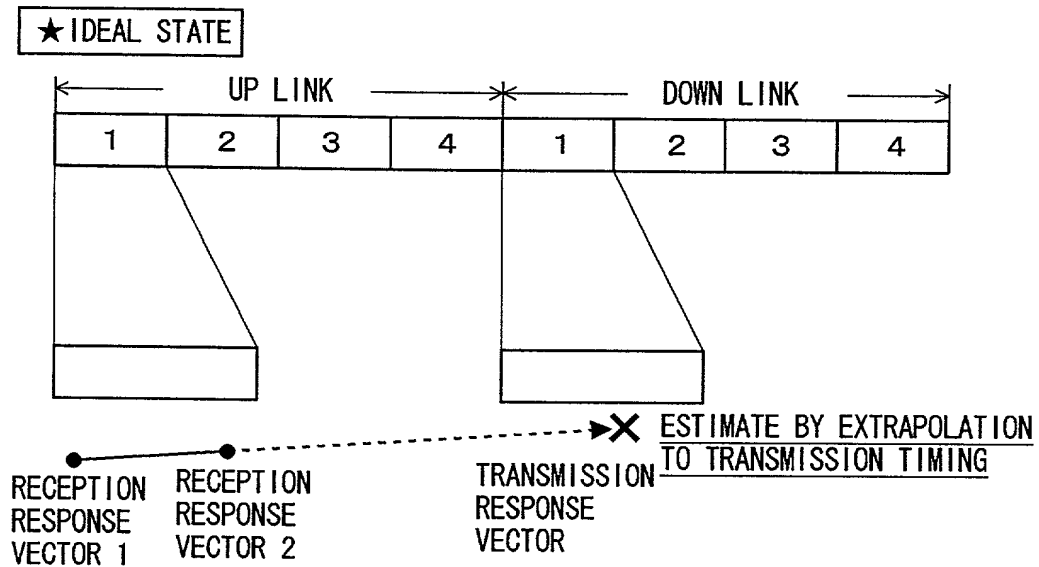

FIG. 4B

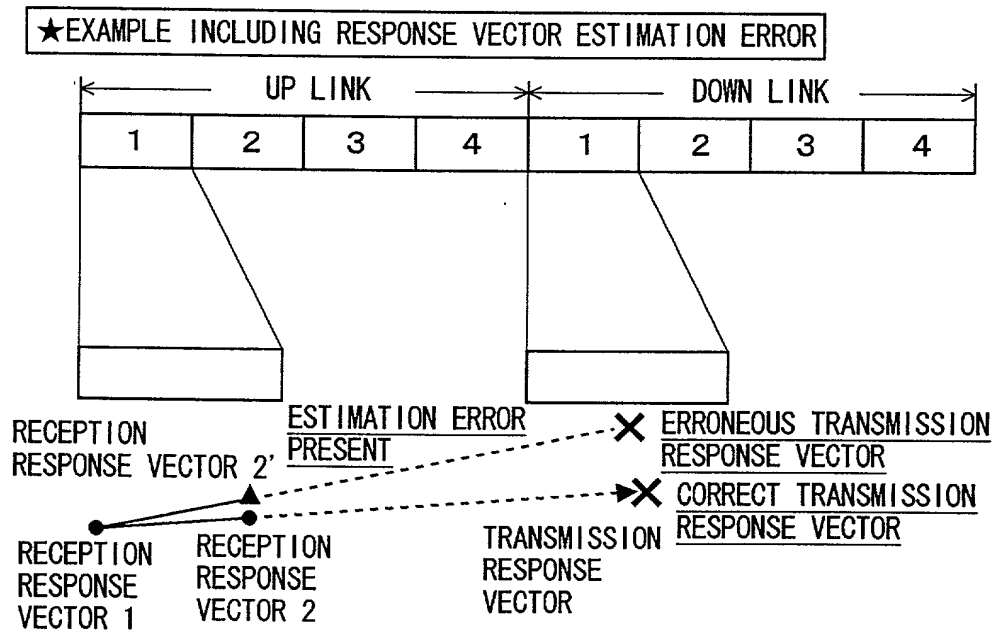
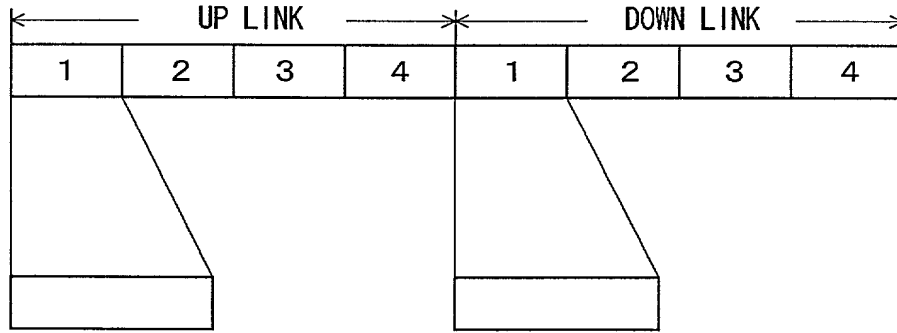
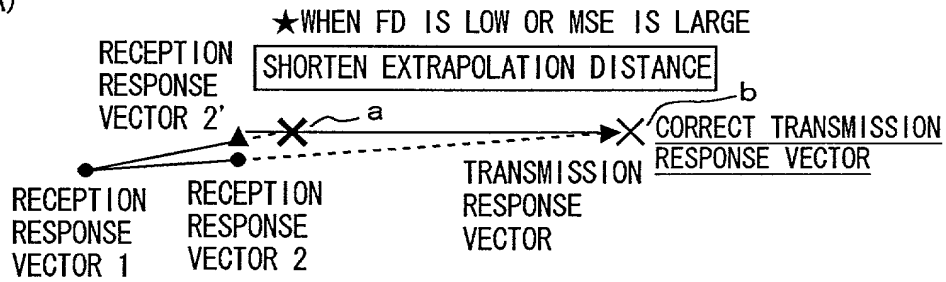

FIG. 5



(A)



(B)

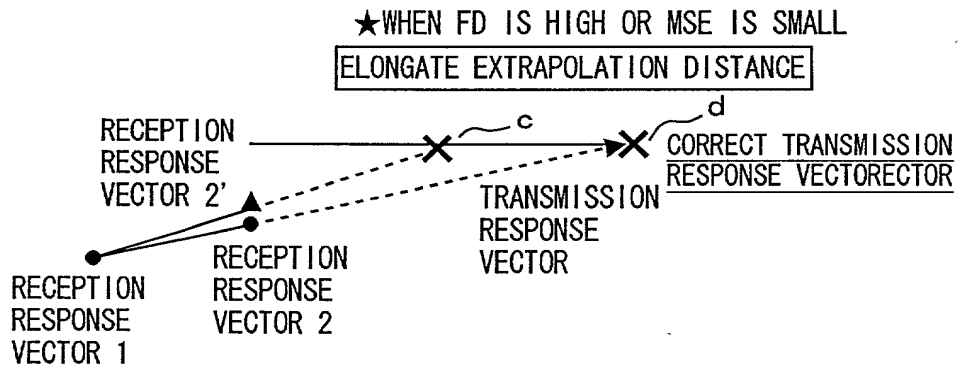

FIG. 6

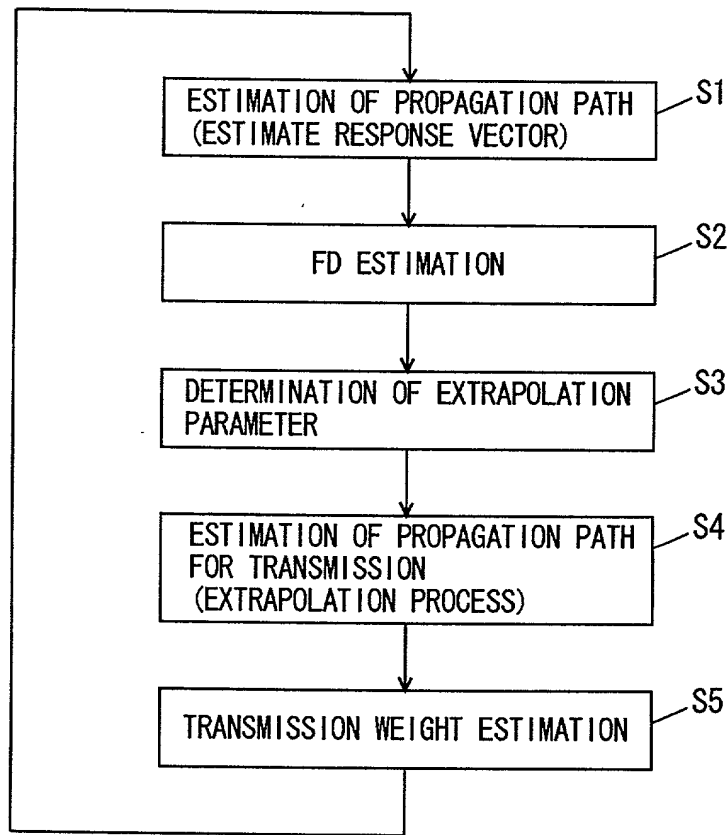

FIG. 7

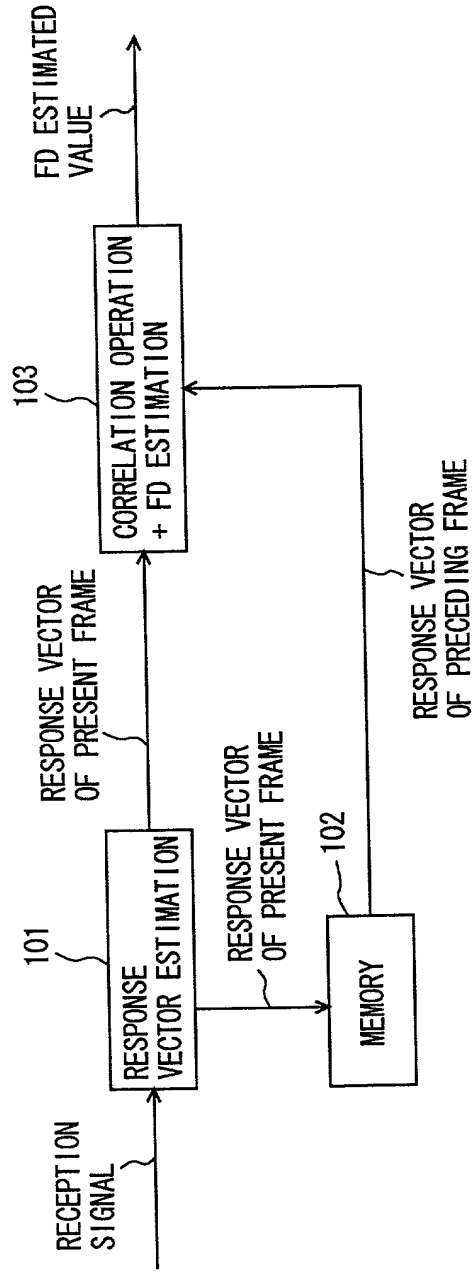

FIG. 8

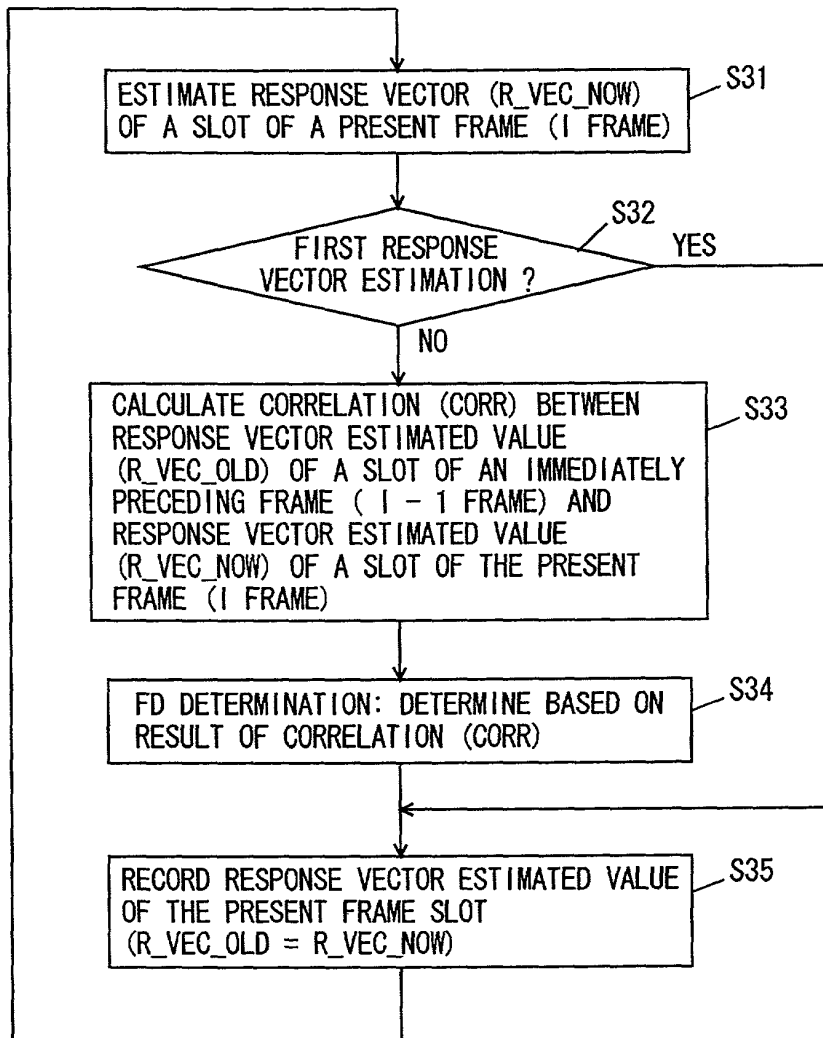

FIG. 9

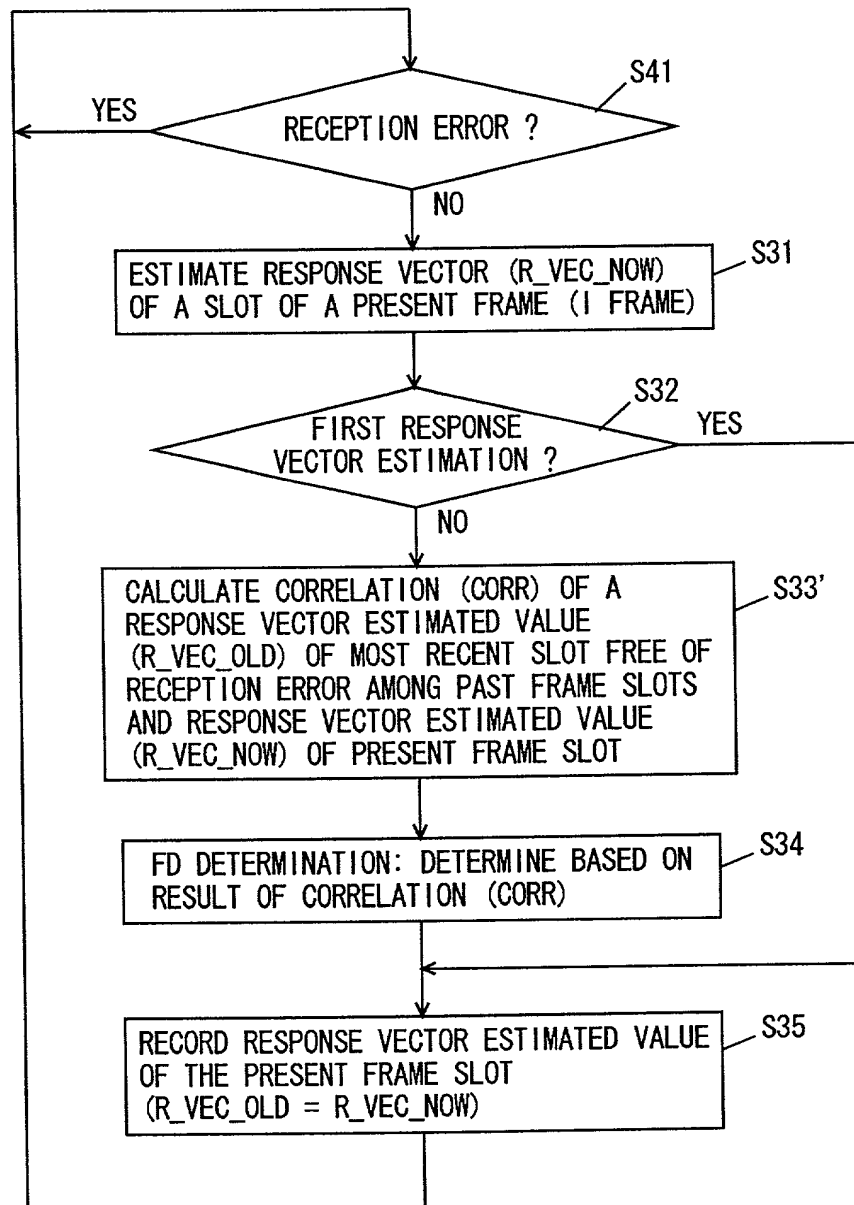

FIG. 9

FIG. 10

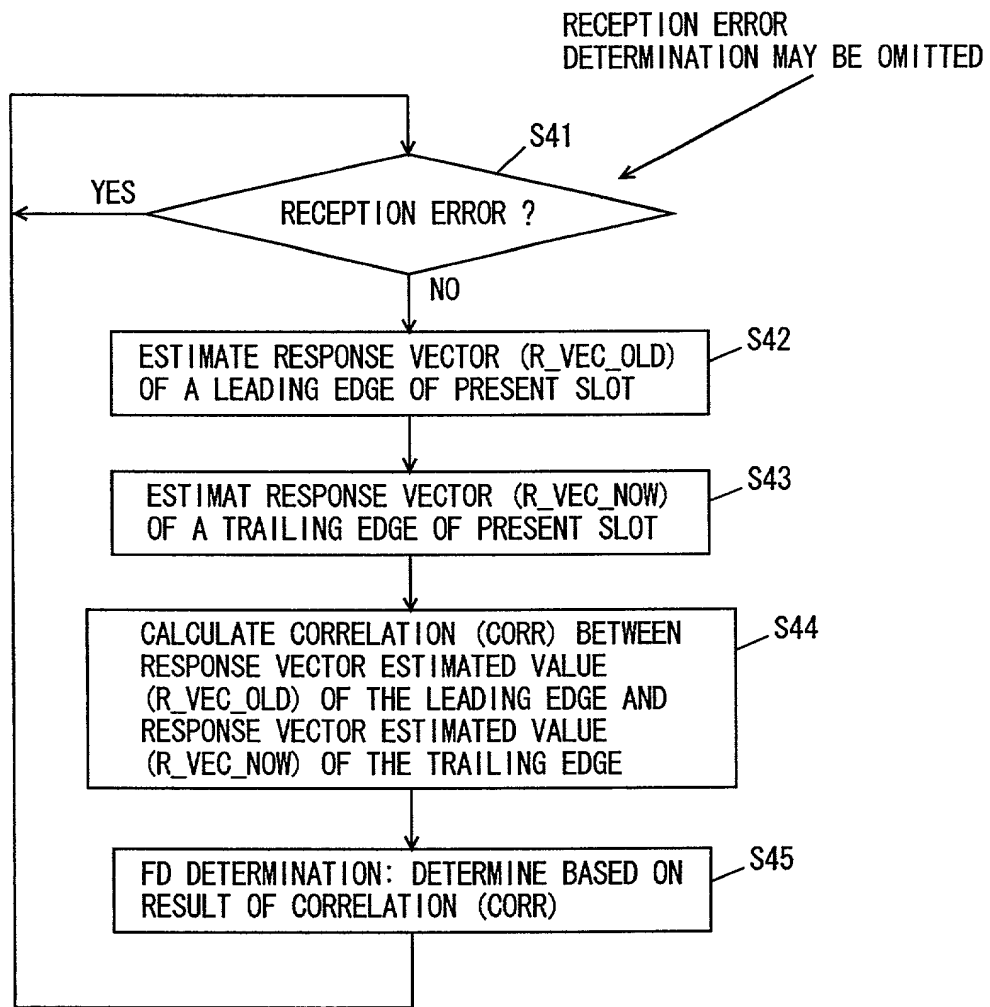

FIG. 11

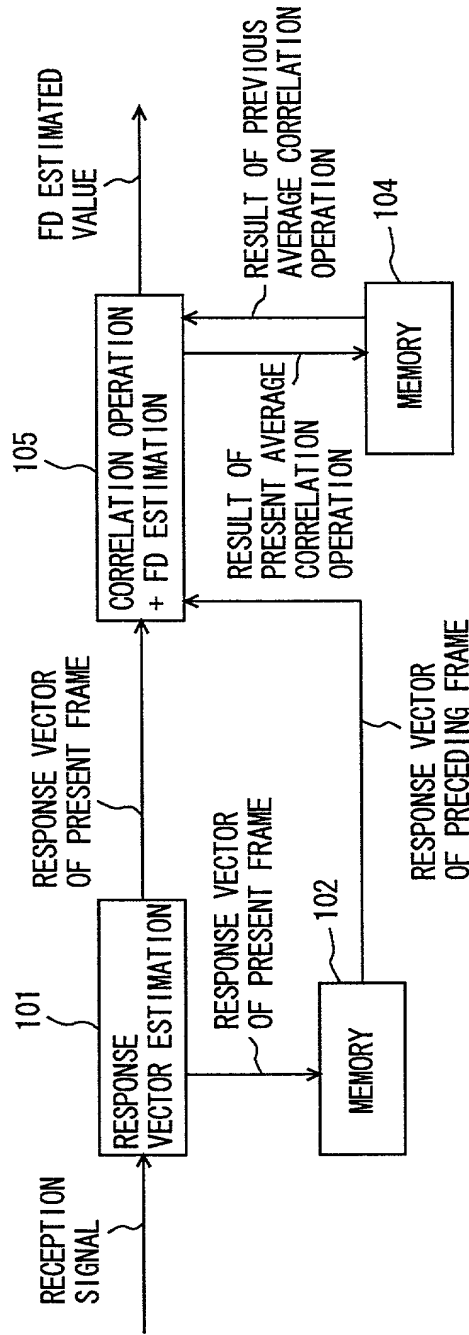

FIG. 13

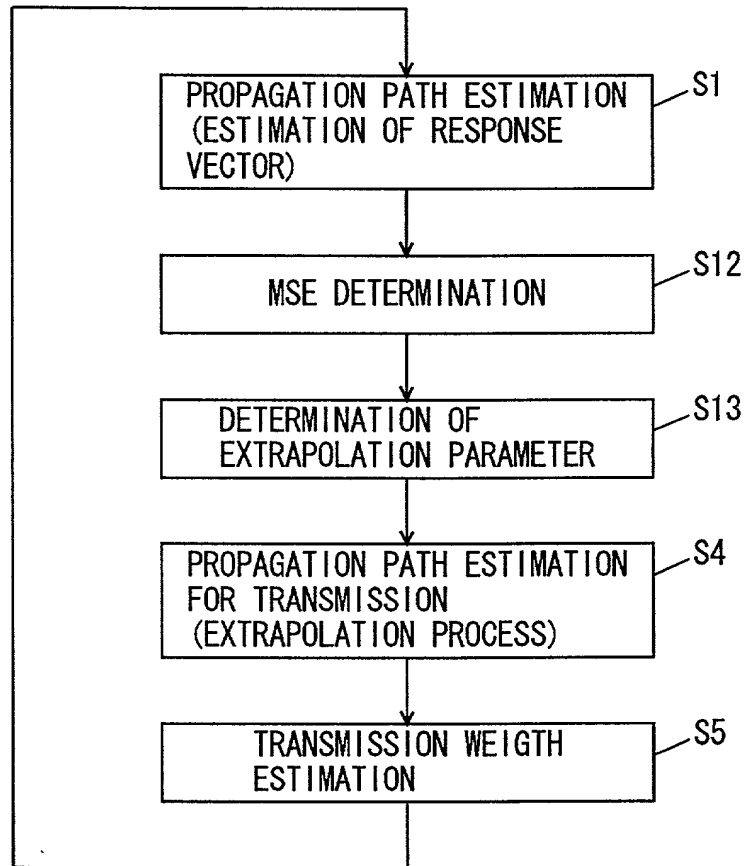
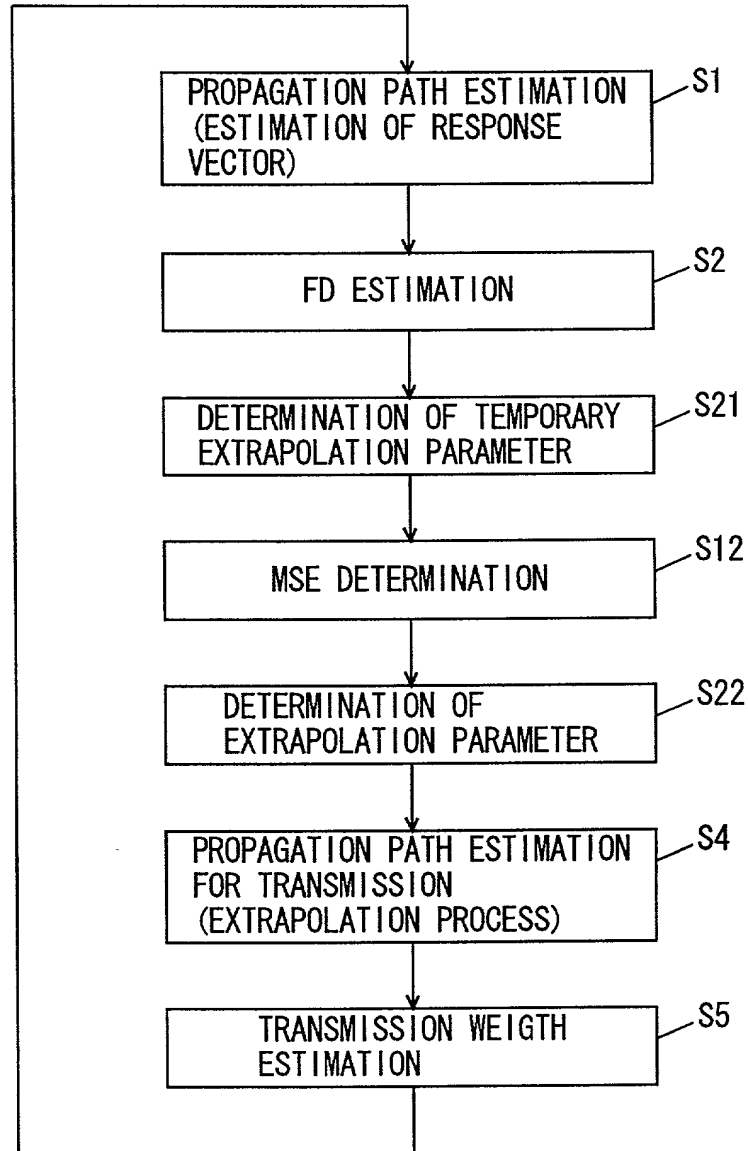
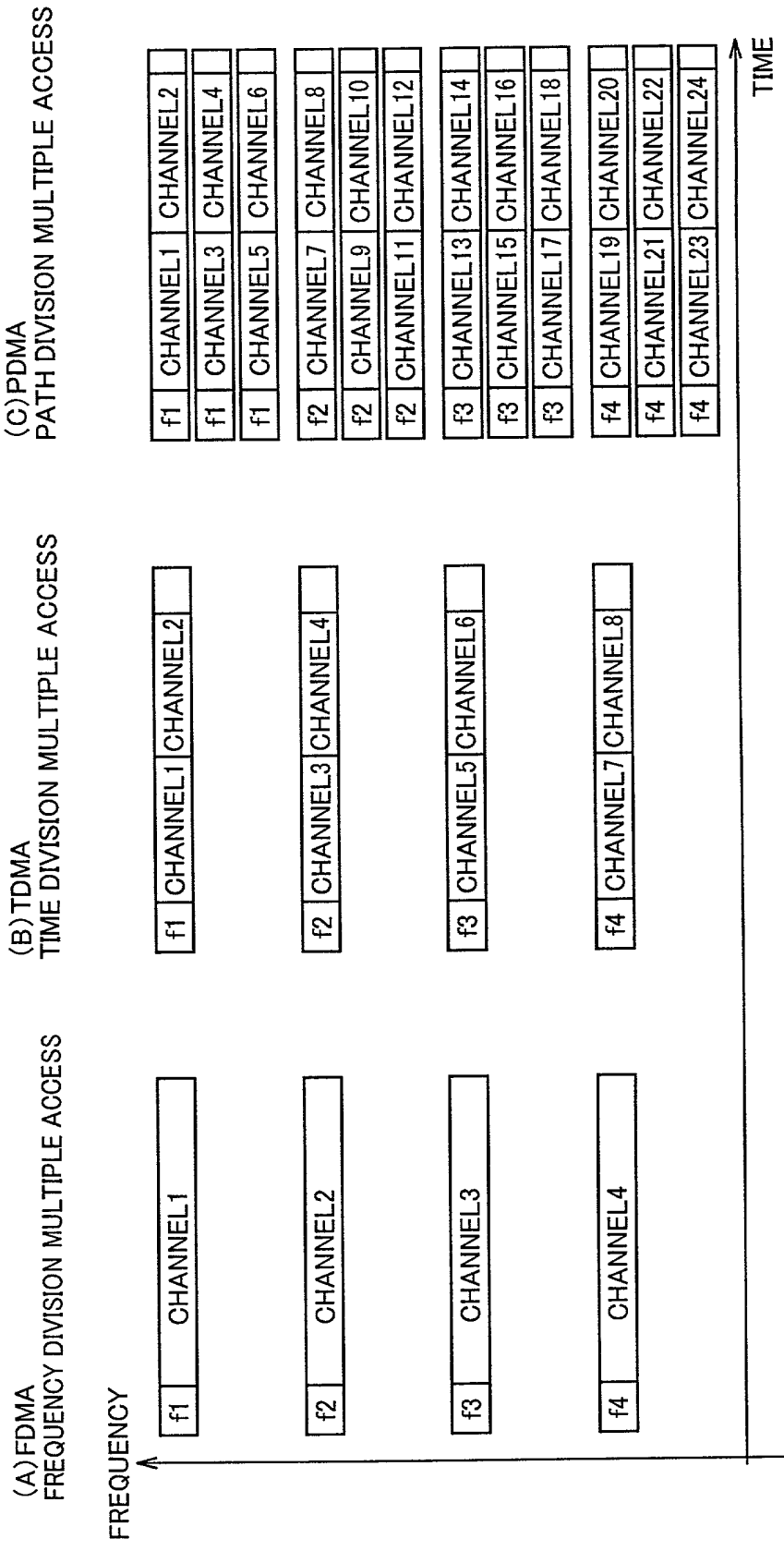

FIG. 14



Copyright © 2000 by Intel Corporation

FIG. 15 PRIOR ART



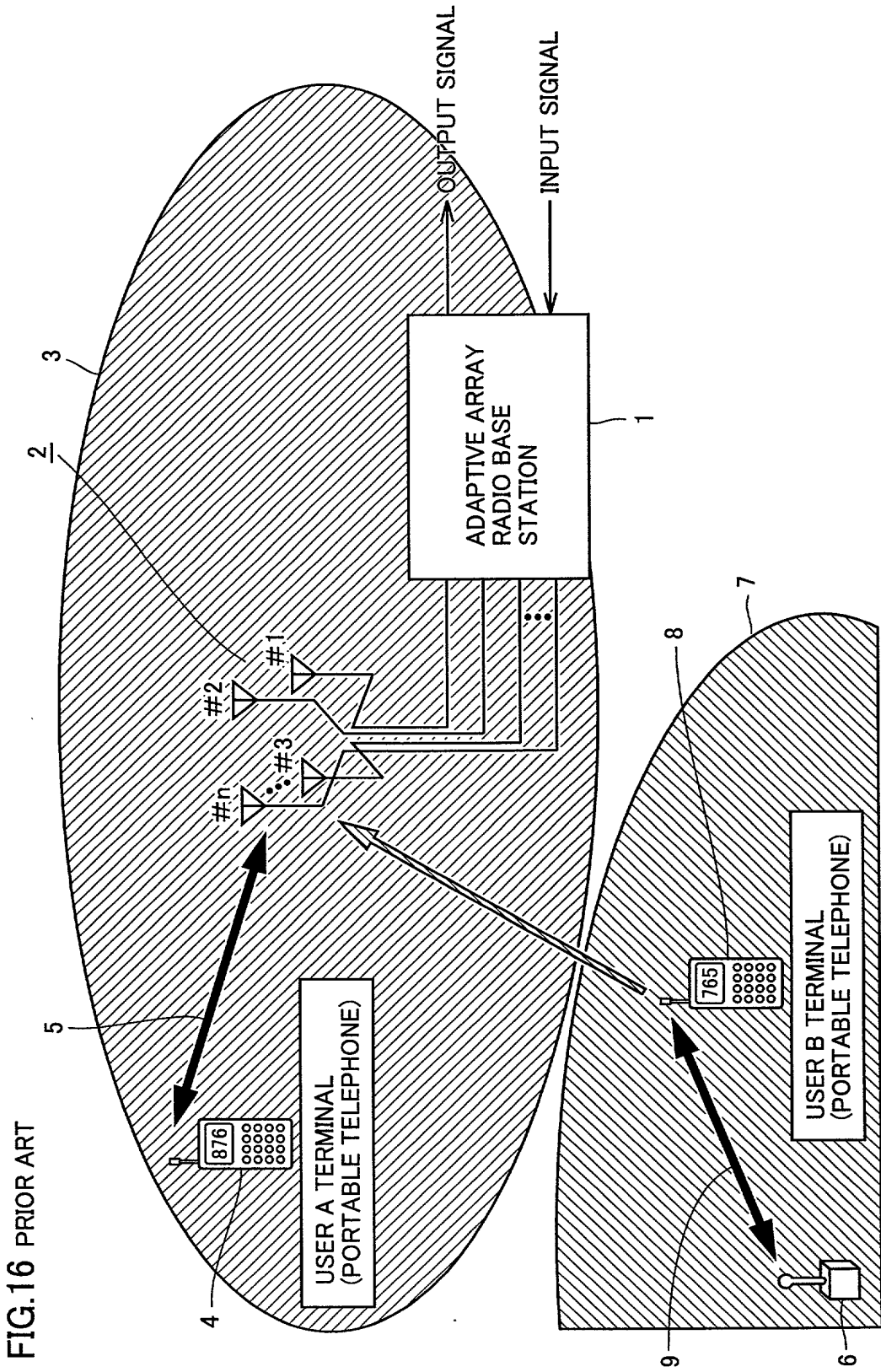

FIG.17 PRIOR ART

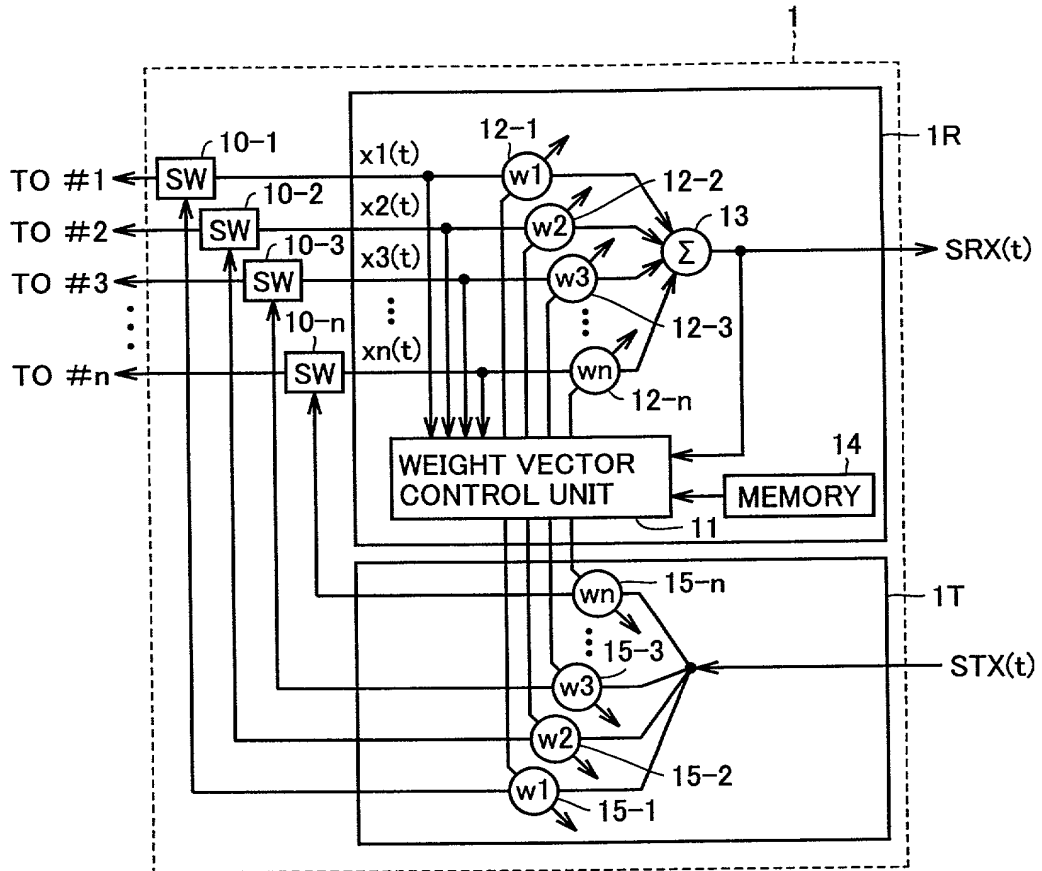

FIG. 18 PRIOR ART

1	0	...	1	0	1	...	0	1
PREAMBLE (SIGNAL SEQUENCE KNOWN TO RADIO BASE STATION)				DATA (VOICE AND THE LIKE) (SIGNAL SEQUENCE NOT KNOWN TO RADIO BASE STATION)				

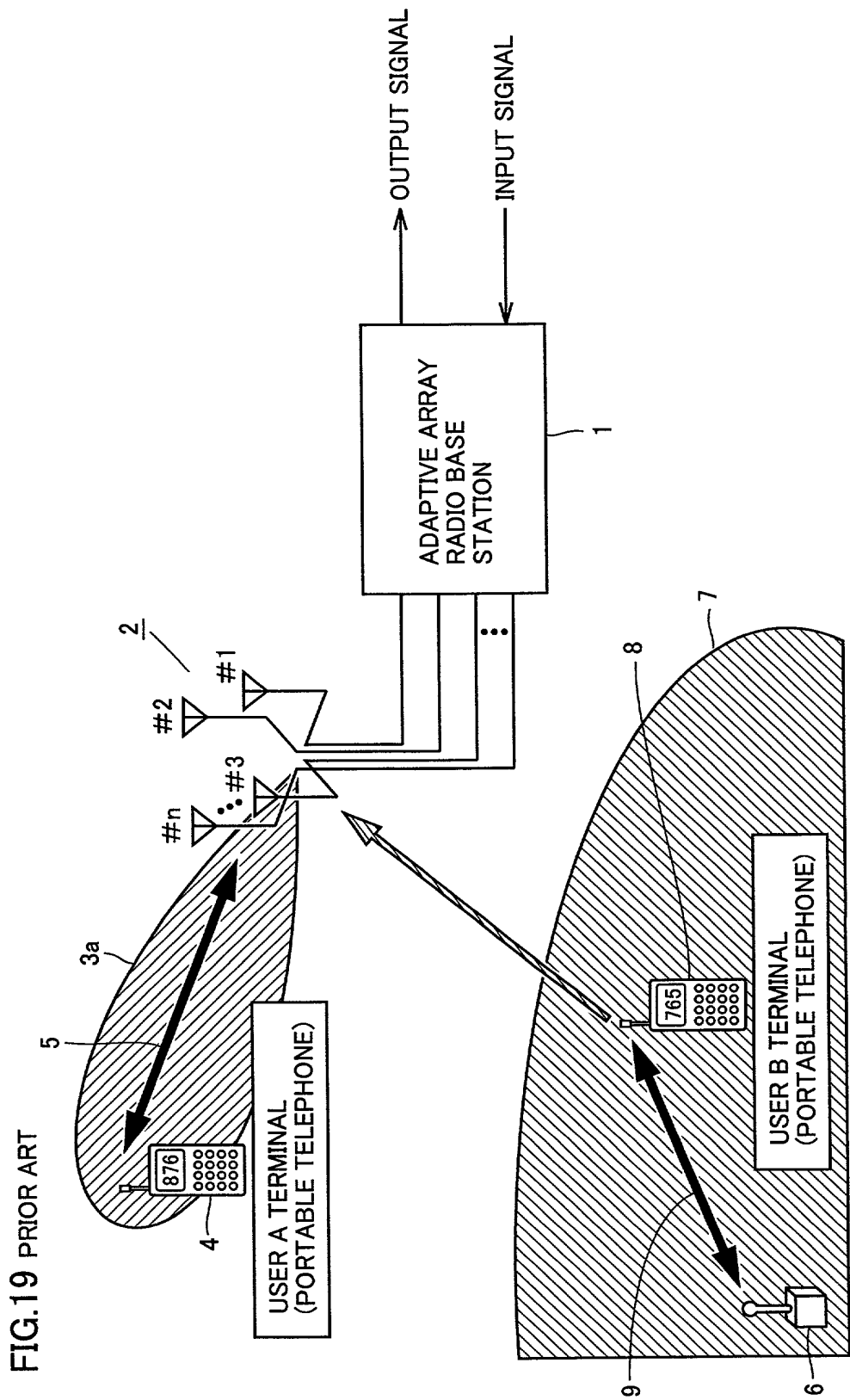

FIG. 19 PRIOR ART